



SANDVIK QI353 HSI IMPACTOR

SANDVIK 3-SERIES 3RD GENERATION



IS YOUR CRUSHER MAKING AN IMPACT?

Does your impact crusher meet your productivity and uptime expectations? Sandvik is revolutionizing impact crushers with the first of our 3-Series 3rd Generation crusher range offering.

The QI353 is the most versatile, mid-sized mobile impactor available today, designed to demand more uptime than any other. Built utilizing Sandvik's market leading Prisec technology, capable of operating in primary and secondary applications.

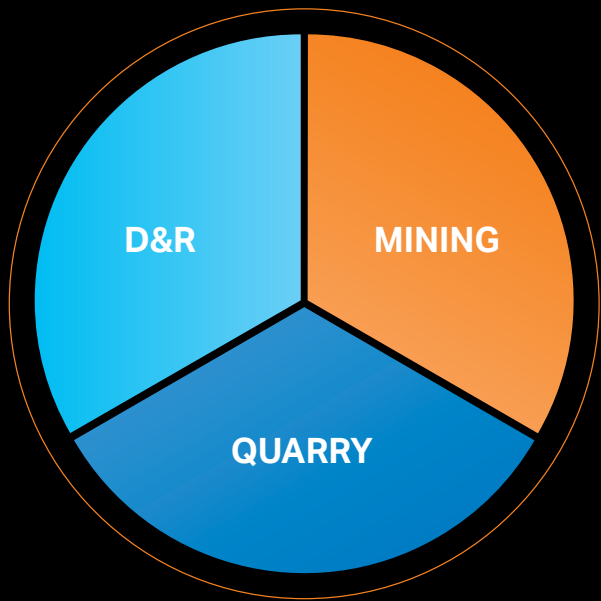

SUSTAINABILITY

Sandvik is committed to using engineering and innovation to advance the world towards sustainable business. An opportunity for new innovations and new ways of working that will drive efficiency and productivity, open new markets, support our customers and help us sustain long-term growth.

To achieve this, Sandvik is focusing on four sustainability goals for 2030;

CIRCULARITY: More than 90% circular

CLIMATE: Halve the CO₂ impact

CHAMPION PEOPLE: Zero harm to people

PLAY FAIR: Always do the right thing



MAKE THE SH/FT



WE BUILD CIRCULARITY

More than 90% circular



WE SHIFT CLIMATE

Halve the CO₂ impact



WE CHAMPION PEOPLE

Zero harm to people



WE PLAY FAIR

Always do the right thing

QI353

- Large feed hopper with hopper extensions
- Hopper capacity 7.3m³ / 9.5 yds³
- Curved wing profile improves material flow and maximizes strength
- Hydraulic folding side wings & patented hydraulic lift and tilt rear door locking
- Faster & safer set-up from ground level
- Sandvik Prisec impact crusher
- Configurable for primary and secondary crushing

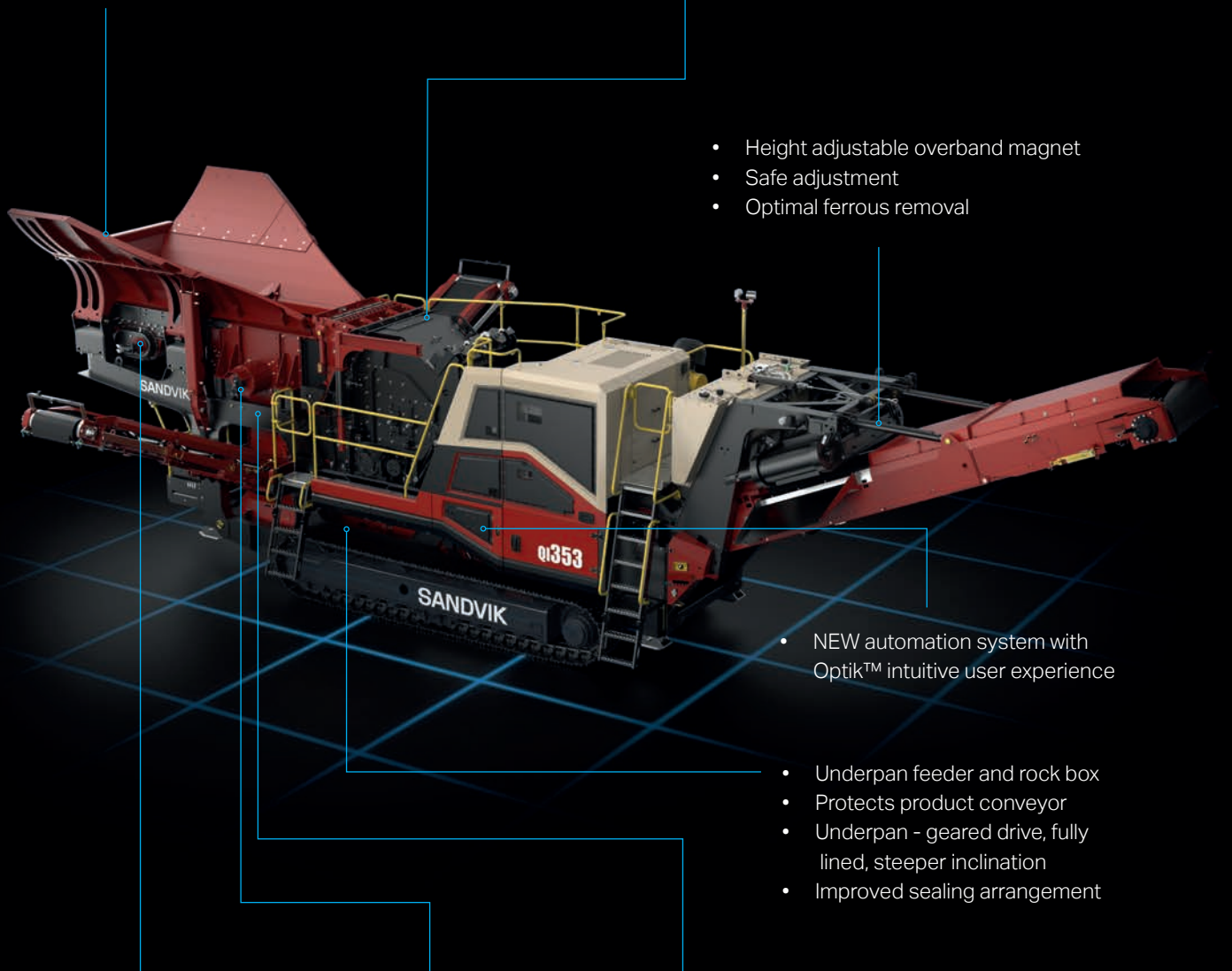

- Height adjustable overband magnet
- Safe adjustment
- Optimal ferrous removal

- NEW automation system with Optik™ intuitive user experience

- Underpan feeder and rock box
- Protects product conveyor
- Underpan - geared drive, fully lined, steeper inclination
- Improved sealing arrangement

- Primary pan feeder
- Featuring geared drive, wear resistant liners
- Automatic load management system

- New vibrating and pre-screen
- Maximize throughput and reduce crusher wear

- Three position by-pass chute
- Choose to discharge, blend or by-pass crusher

QI353

- Hydraulic raise / lower facility on main conveyor
- 1200mm / 47" belt width
- Improved stockpiling capacity (discharge height 4.02m / 13' 2")
- Hydraulic raise and lower, safer for clearing blockages
- Hydraulic folding head section reduced transportation length and aids maintenance access
- Fully enclosed, dust suppression, side mounted spray nozzles
- Prepared for optional belt scales

- Rear access platform
- Improved access to pre-screen media and feeder drive, includes two large storage toolboxes



- Telescopic natural fines conveyor,
- Belt width 650mm / 26"
- Discharge height 2.9m / 9' 6",
- Reversible for LHS or RHS discharge
- Can be lowered for maintenance

- Ground level maintenance points
- Located at ground level for improved operator safety

- 3-sided 270° access to impact crusher for improved service access

QI353

- Latest stage V emissions compliant powerpack
- CAT C9.3B Stage V 310kW / 415hp
- Crusher driven via wet clutch for superior power transfer and fuel efficiency
- Variable speed allows for impactor tip speed optimization
- Less emissions onsite, lower running costs
- Smaller hydraulic tank
- Improved hydraulic oil filtration technology
- 40% less hydraulic oil needed per service
- Lower cost of ownership and better sustainability



- Free flowing feed arrangement
- All components in flow path get wider
- Improved material flow, fewer blockages
- Larger on-board fuel storage
- Storage increased by 15%
- Longer intervals between refills

PRISEC IMPACT CRUSHER

- Market leading Sandvik Priseq impact chamber for unrivalled flexibility and performance
- Adjustable apron curtains and tip speed enable a wide range of end product gradations to be achieved
- Selection of hammers to suit a wide range of applications
- Patented rotor locking and positioning device for quick and safe maintenance
- Unique 4 key trapped system to ensure safe inspection after the rotor has stopped turning
- Includes integrated lifting jib, chain hoist and lifting cradle for safe removal, rotation and fitment of hammers

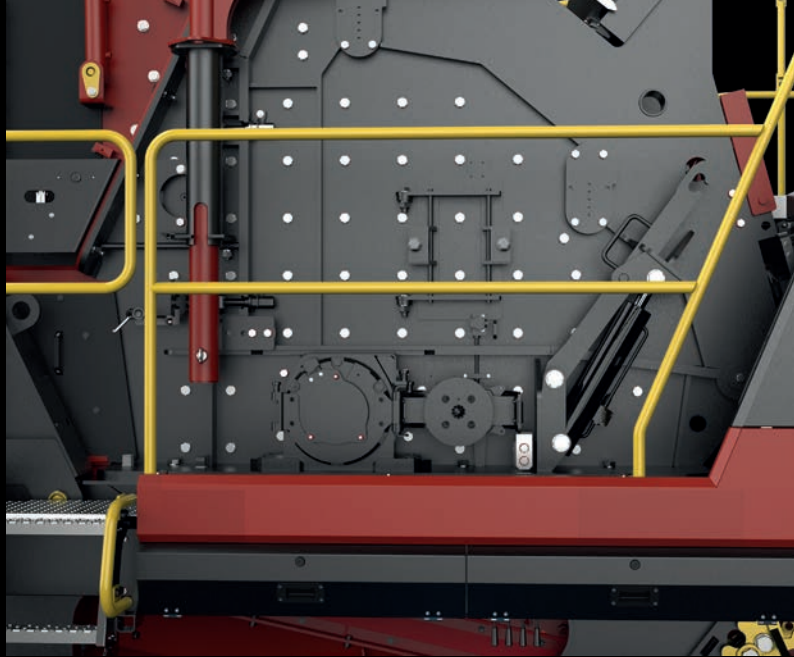

Feed opening	1170 mm x 730 mm / 46" x 29"
Hydraulic inlet opening	1170 mm x 830 mm / 46" x 33"
Rotor type	4 bar rotor
Rotor diameter	1150 mm / 45"
Rotor speed (variable)	603 - 674 rpm
Tip speed (variable)	36 - 43 m/s / 118 - 135 ft/s
Aprons	2 with hydraulic assist



UP TO

400 TPH

(OPEN CIRCUIT NO HANGING SCREEN)

DEMAND MORE. DELIVER ROCK PROCESSING

UPTIME

- The QI353 features a free-flowing feed arrangement where all components in the flow path through the machine get wider, for improved material flow
- Load sensing system for feeder drive, to ensure continuous crushing
- Rock box and underpan feeder featuring wear resistant liners for extended wear life
- Extended service intervals to maximize uptime
- 15% larger on-board fuel storage for longer intervals between refuelling
- Premium components selected throughout and FEA analysis on structural parts for durability
- Steel pipe work used extensively to give superior heat dissipation and maximum reliability
- Capable of operating in the most hostile environments

PRODUCTIVITY

- Large feed hopper with hopper extensions with curved heavy-duty sides for greater capacity and tapered feed arrangement to reduce blockages
- Primary pan feeder featuring geared drive, wear resistant liners
- Pre-screen with choice of screen media for effective removal of fines
- Built utilizing Sandvik's market leading Prisec technology
- Largest feed opening and widest rotor in its class
- Adjustable apron curtains and tip speed enable a wide range of end products to be achieved
- Selection of hammers to suit a wide range of applications
- All plant conveyors have larger discharge heights for increased stockpiling capacity
- Prepared for modular double deck hanging screen as standard

UP TO

64% LESS

HYDRAULIC OIL CONSUMED OVER 10,000HRS OF MACHINE USAGE
(SUBJECT TO OIL SAMPLING)

EFFICIENCY

- The QI353 has been designed to consume less energy
- Double deck pre-screen to ensure maximum scalping capability. Prevent any undersize material passing through the impactor, maximizing throughput and reducing wear costs
- Largest rotor diameter in its class, conserves more energy whilst also reducing fuel consumption
- Fluid clutch drive for smoother power transmission for optimum fuel efficiency and maximum power transfer
- Latest generation fuel efficient powerpack provides maximum performance and cost efficiency

FLEXIBILITY

- Boasting a high degree of flexibility to suit any application, the QI353 is particularly useful for contractors who change jobs frequently
- Telescopic natural fines conveyor can be positioned for right or left hand discharge
- Three position by-pass chute under the pre-screen allows you to decide where to send your natural fines. Choose to discharge, blend or bypass crusher

HS323 OPTIONAL HANGING SCREEN MODULE

- The HS323 enhancements; prepared to accept belt scales for TPH monitoring on fines and stockpile conveyor belts, subframe enhanced for improved screen media access and tensioning and an updated mid-size stockpile conveyor
- Set-up in less than 30 minutes and can be fitted without the use of additional lifting equipment
- 4m x 1.5m / 13' x 5' double deck hanging screen module
- Complete with re-circulating conveyor and optional stockpile conveyor
- Allows machine to produce two screened products and recirculate oversize back into the feed hopper
- Oversize conveyor can be hydraulically rotated through 90° to stockpile
- Provides a 1, 2 or 3 way split



PLANT PERFORMANCE

700 MM / 28"

MAX FEED SIZE

UP TO

400 TPH / 441 STPH

CAPACITY



INNOVATION

UP TO

10 TONNES

PER LITRE ENSURING LOW COST
PER TONNE PERFORMANCE

- Hydraulic folding side wings with patented hydraulic lift and tilt rear door locking
- FEA (Finite Element Analysis) optimized hopper and chassis to reduce weight and increase strength
- Reversible telescopic natural fines conveyor
- NEW automation system featuring Optik™ intuitive user experience
- Patented
 - Hydraulic lift and tilt rear hopper door locking
 - Rotor locking and positioning device for quick and safe maintenance
 - Adjustment / braking system for relieving blockages whilst in operation
 - Prisec technology, configurable for primary and secondary applications
 - Hammer retention system
 - Hanging screen module & screen positioning system
- New belt tensioning device (Patent pending)



SAFETY

Patented rotor locking and positioning device for quick and safe maintenance

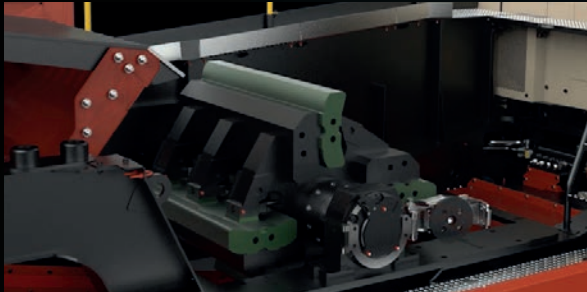

Unique 4 key trapped system to ensure safe inspection after the rotor has stopped turning

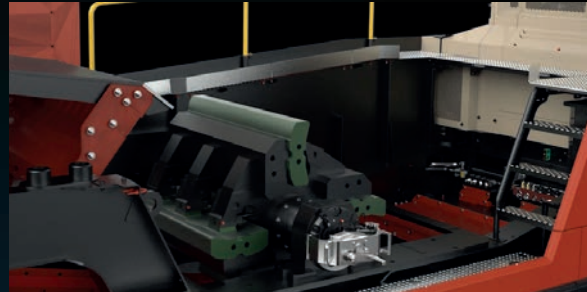

Includes integrated lifting jib, chain hoist and lifting cradle for safe removal, rotation and fitment of hammers

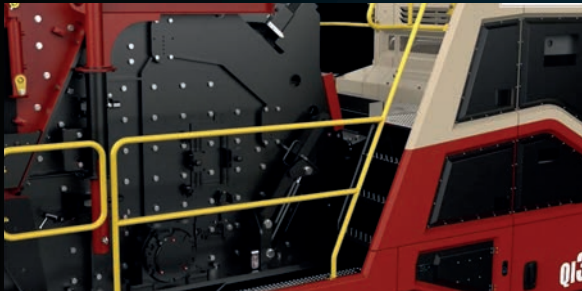

Mandatory audible and visual warning for safe operation whilst tracking and start-up / shut down

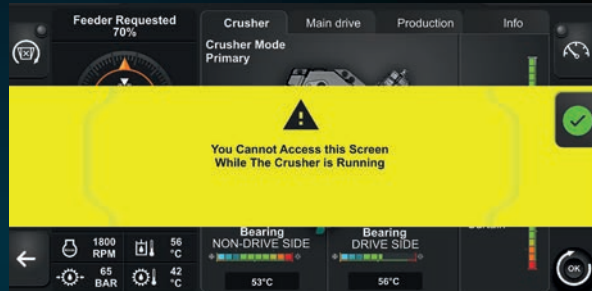

Emergency stop buttons and conveyor pull stop cords around the plant for easy access during operation

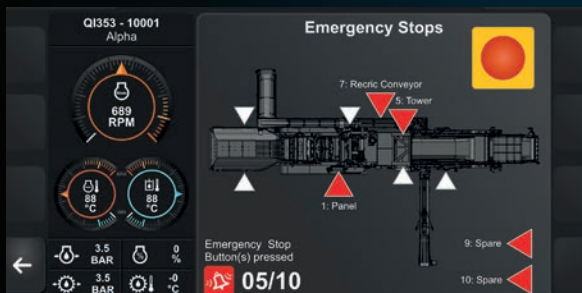

Wireless radio handset and proportional speed control for safe tracking onsite



Spacious platforms provide safe access for service and maintenance

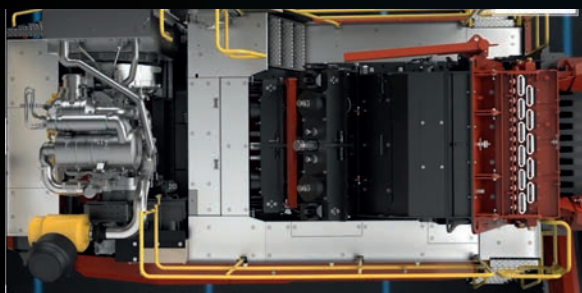

Dust suppression spray bars and onboard water pump to minimize dust improving operator and onsite safety



CONNECTIVITY

OPERATIONS ARE IN YOUR CONTROL

INTUITIVE CONTROL

Optik™ intuitive user experience, simplified operation controls and total integration with My Fleet telematics solution.

MAXIMIZE UPTIME

Real time information

OPTIMIZE DECISION MAKING

Accurate data collection

BOOST OUTPUT

Diagnostic assistance

ENHANCE TROUBLESHOOTING

Pre-installed guides

EASY NAVIGATION

User-friendly dashboard



MY FLEET



Get in-depth insights into your connected crusher with Sandvik My Fleet. It's the smart, intelligent way of monitoring crusher behavior and using that information to optimize and improve business performance. Now you can make informed business decisions using accurate, reliable data.

Connected to Sandvik My Fleet with 7-year data subscription. Benefits include 24/7 fleet management, geofencing and remote operator support.



SECURITY+

SECURITY+ is a scheme developed to extend the warranty on Sandvik mobile crushers and screens beyond our standard terms and conditions.

WHAT BENEFITS DOES THIS OFFER THE CUSTOMER?

- Improved reliability, increased uptime and productivity
- Peace of mind through extended warranty coverage
- A guarantee that only genuine Sandvik spares are used on the machine
- Results in higher residual (re-sell) value of the equipment



HIGHER
UPTIME



PEACE
OF MIND



AFTERMARKET
SALES GROWTH



INCREASED
MAINTENANCE
EFFICIENCY



HIGHER RESIDUAL
VALUE



TRANSPORT DIMENSIONS

NO HANGING SCREEN

Length	14,05 m / 46' 1"
Width	3,16 m / 10' 5" (HS Recirc Chute Fitted) 2,8 m / 9' 3" (HS Recirc Chute Removed)
Height	3,46 m / 11' 4"
Weight	45,500 kg / 100,310 lbs



WITH HANGING SCREEN

Length HS	18,3 m / 60' 8"
Width HS	3,58 m / 11' 9"
Height HS	3,66 m / 12'
Transport weight HS	55,900kg / 123,240 lbs



AFTERMARKET OFFERING

We have developed several aftermarket packages, designed for the customer level of usage. These are introduced in the parts manuals for our new 3-series Q-Range crushers and will fall under three categories - Maintenance, Repair and Overhaul.

MAINTENANCE, REPAIR, OVERHAUL PACKAGES

These packages ensure you have parts available to avoid any unnecessary downtime. Having spare parts when your customers need them is paramount.

01  **MAINTENANCE PACKAGE**
Faster wearing items.

02  **REPAIR PACKAGE**
Slower moving items where high usage is not expected.

03  **OVERHAUL PACKAGE**
Items which we would not expect to be required under standard operating conditions.

ENDURANCE PACKAGES

Having spare parts available at the time when your customers need them most is paramount. Regular and efficient maintenance is vital to your productivity but in the event of an unexpected breakdown, you need to have the replacement parts available to hand immediately in order to avoid any unnecessary downtime. Our new Packages will ensure that you have all the relevant parts and consumables in stock giving you peace of mind.

The kits are designed around "best practice" repair and replace, and include all items required for professional repair, removing the concern of secondary failure. Each kit is available individually to allow selection on our portal that best suits each customer's needs. No two applications are the same, so having this flexibility to select the type and package quantity to suit individual needs is crucial to delivering optimum performance and support.

04  **ENDURANCE PACKAGE**
Selection of packages which can be tailored to specific customer's needs for high hour operations, to maximize uptime and performance.



B5-341 ENG © Sandvik Rock Processing Solutions 2021. SANDVIK is a registered trademark owned by Sandvik Intellectual Property AB in Sweden and other countries. Subject to change without notice.